

BSP75N

60V self-protected low-side Intellifet™ MOSFET switch

Summary

Continuous drain source voltage	$V_{DS}=60V$
On-state resistance	500mΩ
Maximum nominal load current ^(a)	1.1A ($V_{IN} = 5V$)
Minimum nominal load current ^(c)	0.7A ($V_{IN} = 5V$)
Clamping energy	550mJ

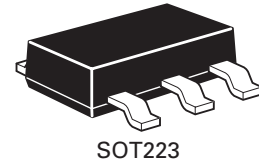

Description

Self-protected low side MOSFET. Monolithic over temperature, over current, over voltage (active clamp) and ESD protected logic level functionality. Intended as a general purpose switch.

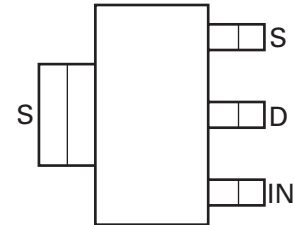

Features

- Short circuit protection with auto restart
- Over-voltage protection (active clamp)
- Thermal shutdown with auto restart
- Over-current protection
- Input protection (ESD)
- High continuous current rating
- Load dump protection (actively protects load)
- Logic level input

Note:

The tab is connected to the source pin and must be electrically isolated from the drain pin. Connection of significant copper to the drain pin is recommended for best thermal performance.

Ordering information

Device	Reel size (inches)	Tape width (mm)	Quantity per reel
BSP75NTA	7	12mm embossed	1000

Device marking

BSP75N

Functional block diagram

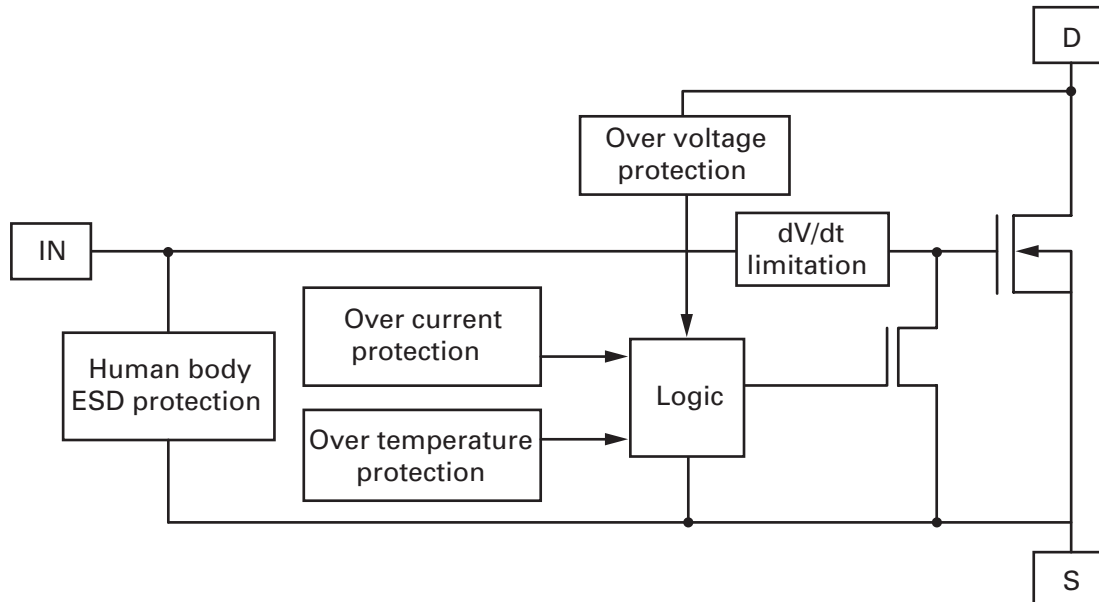

Applications

- Especially suited for loads with a high in-rush current such as lamps and motors.
- All types of resistive, inductive and capacitive loads in switching applications.
- μC compatible power switch for 12V and 24V DC applications.
- Automotive rated.
- Replaces electromechanical relays and discrete circuits.

Linear mode capability - the current-limiting protection circuitry is designed to de-activate at low V_{ds} , in order not to compromise the load current during normal operation. The design maximum DC operating current is therefore determined by the thermal capability of the package/board combination, rather than by the protection circuitry. This does not compromise the products ability to self protect itself at low V_{DS} .

Absolute maximum ratings

Parameter	Symbol	Limit	Unit
Continuous drain-source voltage	V_{DS}	60	V
Drain-source voltage for short circuit protection $V_{IN} = 5V$	$V_{DS(SC)}$	36	V
Drain-source voltage for short circuit protection $V_{IN} = 10V$	$V_{DS(SC)}$	20	V
Continuous input voltage	V_{IN}	-0.2 ... +10	V
Peak input voltage	V_{IN}	-0.2 ... +20	V
Operating temperature range	T_j	-40 to +150	°C
Storage temperature range	T_{stg}	-55 to +150	°C
Power dissipation at $T_A = 25^\circ C$ ^(a)	P_D	1.5	W
Power dissipation at $T_A = 25^\circ C$ ^(c)	P_D	0.6	W
Continuous drain current @ $V_{IN}=10V$; $T_A=25^\circ C$ ^(a)	I_D	1.3	A
Continuous drain current @ $V_{IN}=5V$; $T_A=25^\circ C$ ^(a)	I_D	1.1	A
Continuous drain current @ $V_{IN}=5V$; $T_A=25^\circ C$ ^(c)	I_D	0.7	A
Continuous source current (body diode) ^(a)	I_S	2.0	A
Pulsed source current (body diode) ^(b)	I_S	3.3	A
Unclamped single pulse inductive energy	E_{AS}	550	mJ
Load dump protection	$V_{LoadDump}$	80	V
Electrostatic discharge (human body model)	V_{ESD}	4000	V
DIN humidity category, DIN 40 040		E	
IEC climatic category, DIN IEC 68-1		40/150/56	

Thermal resistance

Parameter	Symbol	Limit	Unit
Junction to ambient ^(a)	$R_{\theta JA}$	83	°C/W
Junction to ambient ^(b)	$R_{\theta JA}$	45	°C/W
Junction to ambient ^(c)	$R_{\theta JA}$	208	°C/W

NOTES:

(a) For a device surface mounted on 25mm x 25mm x 1.6mm FR4 board with a high coverage of single sided 2oz weight copper. Allocation of 6cm² copper 33% to source tab and 66% to drain pin with tab and drain pin electrically isolated.

(b) For a device surface mounted on FR4 board as (a) and measured at $t \leq 10s$.

(c) For a device surface mounted on FR4 board with the minimum copper required for connections.

Electrical characteristics (at $T_{AMB} = 25^{\circ}\text{C}$ unless otherwise stated)

Parameter	Symbol	Min.	Typ.	Max.	Unit	Conditions
Static characteristics						
Drain-source clamp voltage	$V_{DS(AZ)}$	60	70	75	V	$I_D=10\text{mA}$
Off-state drain current	I_{DSS}		0.1	3	μA	$V_{DS}=12\text{V}, V_{IN}=0\text{V}$
Off-state drain current	I_{DSS}		3	15	μA	$V_{DS}=32\text{V}, V_{IN}=0\text{V}$
Input threshold voltage (*)	$V_{IN(th)}$	1	2.1		V	$V_{DS}=V_{GS}, I_D=1\text{mA}$
Input current	I_{IN}		0.7	1.2	mA	$V_{IN}=+5\text{V}$
Input current	I_{IN}		1.5	2.7	mA	$V_{IN}=+7\text{V}$
Input current	I_{IN}		4	7	mA	$V_{IN}=+10\text{V}$
Static drain-source on-state resistance	$R_{DS(on)}$		520	675	$\text{m}\Omega$	$V_{IN}=+5\text{V}, I_D=0.7\text{A}$
Static drain-source on-state resistance	$R_{DS(on)}$		385	550	$\text{m}\Omega$	$V_{IN}=+10\text{V}, I_D=0.7\text{A}$
Current limit (†)	$I_{D(LIM)}$	0.7	1.0	1.5	A	$V_{IN}=+5\text{V}, V_{DS}>5\text{V}$
Current limit (†)	$I_{D(LIM)}$	1.0	1.8	2.3	A	$V_{IN}=+10\text{V}, V_{DS}>5\text{V}$
Dynamic characteristics						
Turn-on time (V_{IN} to 90% I_D)	t_{on}		3.0	10	μs	$R_L=22\Omega, V_{DD}=12\text{V}, V_{IN}=0$ to $+10\text{V}$
Turn-off time (V_{IN} to 90% I_D)	t_{off}		13	20	μs	$R_L=22\Omega, V_{DD}=12\text{V}, V_{IN}=+10\text{V}$ to 0V
Slew rate on (70 to 50% V_{DD})	$-dV_{DS}/dt_{on}$		8	20	$\text{V}/\mu\text{s}$	$R_L=22\Omega, V_{DD}=12\text{V}, V_{IN}=0$ to $+10\text{V}$
Slew rate off (50 to 70% V_{DD})	dV_{DS}/dt_{off}		3.2	10	$\text{V}/\mu\text{s}$	$R_L=22\Omega, V_{DD}=12\text{V}, V_{IN}=+10\text{V}$ to 0V
Protection functions (‡)						
Required input voltage for over temperature protection	V_{PROT}	4.5			V	
Thermal overload trip temperature	T_{JT}	150	175		$^{\circ}\text{C}$	
Thermal hysteresis			1		$^{\circ}\text{C}$	
Unclamped single pulse inductive energy $T_j=25^{\circ}\text{C}$	E_{AS}	550			mJ	$I_{D(ISO)}=0.7\text{A}, V_{DD}=32\text{V}$
Unclamped single pulse inductive energy $T_j=150^{\circ}\text{C}$		200			mJ	$I_{D(ISO)}=0.7\text{A}, V_{DD}=32\text{V}$
Inverse diode						
Source drain voltage	V_{SD}			1	V	$V_{IN}=0\text{V}, -I_D=1.4\text{A}$

NOTES:

(*) The drain current is limited to a reduced value when V_{DS} exceeds a safe level.

(†) Protection features may operate outside spec for $V_{IN}<4.5\text{V}$.

(‡) Integrated protection functions are designed to prevent IC destruction under fault conditions described in the datasheet. Fault conditions are considered as "outside" normal operating range. Protection functions are not designed for continuous, repetitive operation.

Application information

The current-limit protection circuitry is designed to de-activate at low V_{DS} to prevent the load current from being unnecessarily restricted during normal operation. The design max DC operating current is therefore determined by the thermal capability of the package/board combination, rather than by the protection circuitry (see graph on page 7 'Typical Output Characteristic'). This does not compromise the products ability to self protect at low V_{DS} .

The overtemperature protection circuit trips at a minimum of 150°C. So the available package dissipation reduces as the maximum required ambient temperature increases. This leads to the following maximum recommended continuous operating currents.

Minimum copper area characteristics

For minimum copper condition as described in note (c)

Max. ambient temperature T_{amb}	Maximum continuous current	
	$V_{IN} = 5V$	$V_{IN} = 10V$
25°C @ $V_{IN} = 5V$	720	840
70°C @ $V_{IN} = 5V$	575	670
85°C @ $V_{IN} = 5V$	520	605
125°C @ $V_{IN} = 5V$	320	375

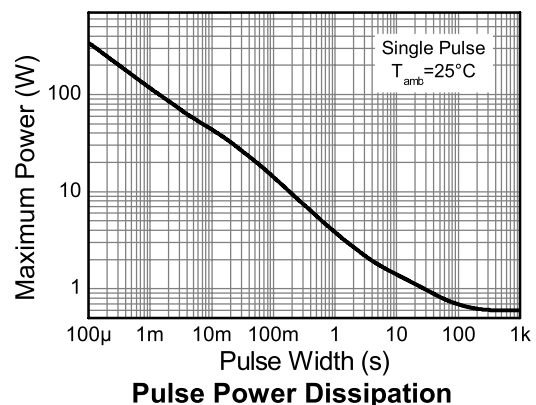
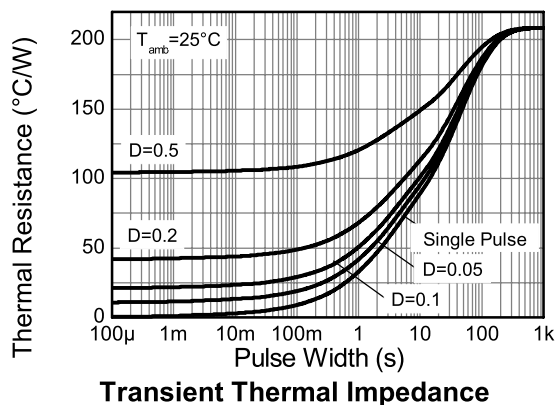
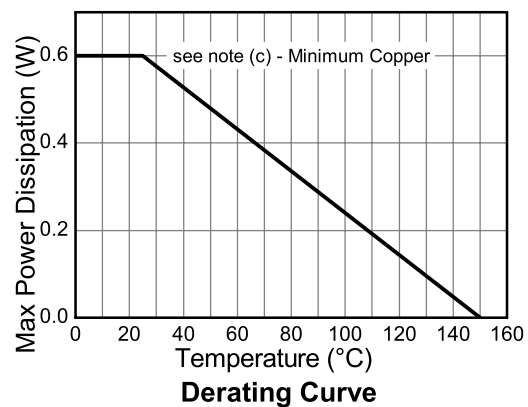
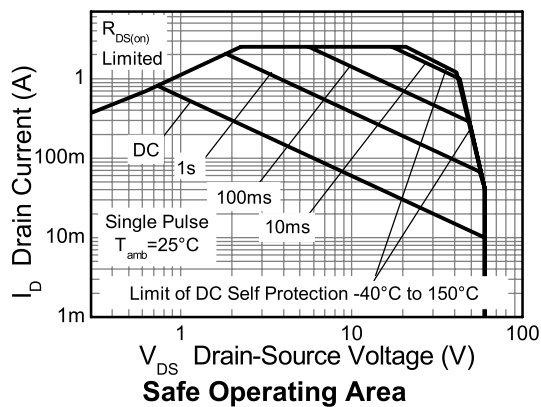

Large copper area characteristics

For large copper area as described in note (a)

Max. ambient temperature T_{amb}	Maximum continuous current	
	$V_{IN} = 5V$	$V_{IN} = 10V$
25°C @ $V_{IN} = 5V$	1140	1325
70°C @ $V_{IN} = 5V$	915	1060
85°C @ $V_{IN} = 5V$	825	955
125°C @ $V_{IN} = 5V$	510	590

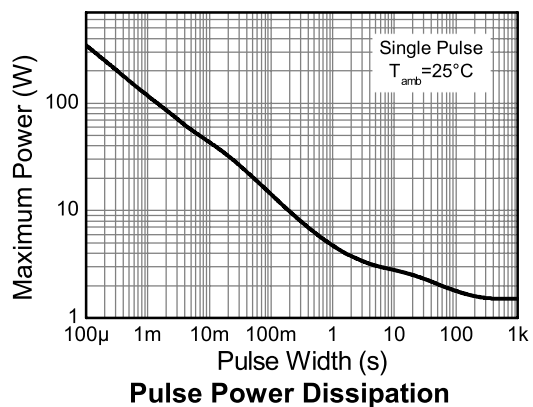
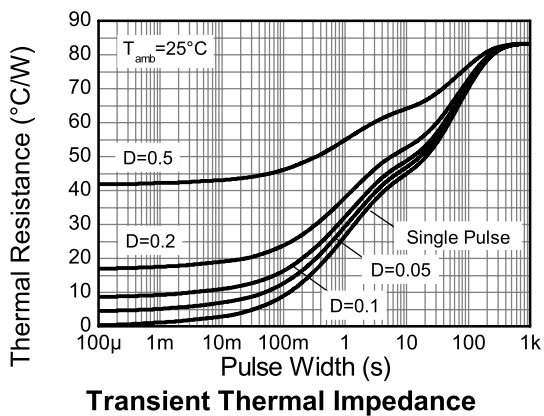
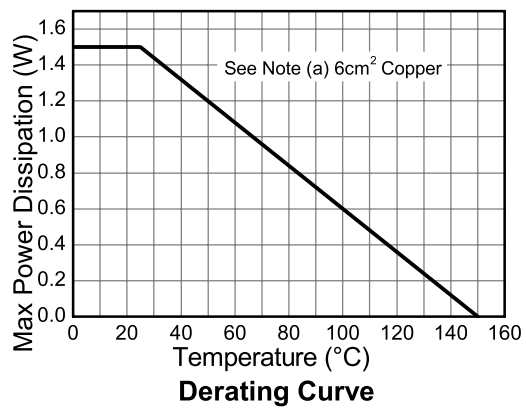
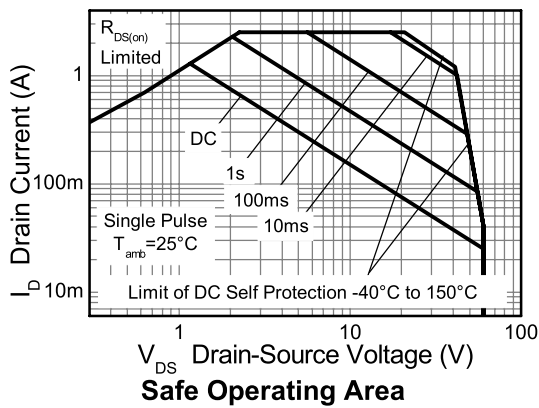

Typical characteristics

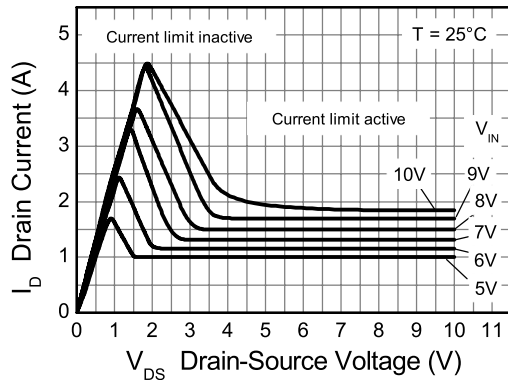

Typical Output Characteristic

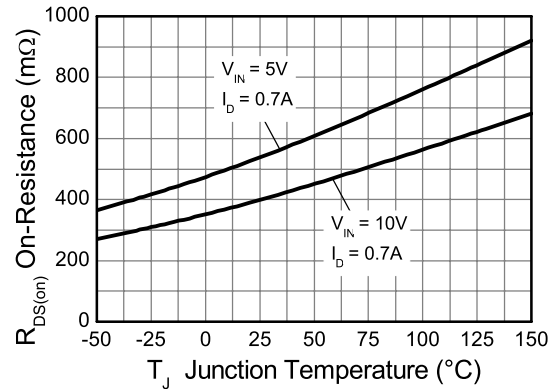

On-state Resistance vs Temperature

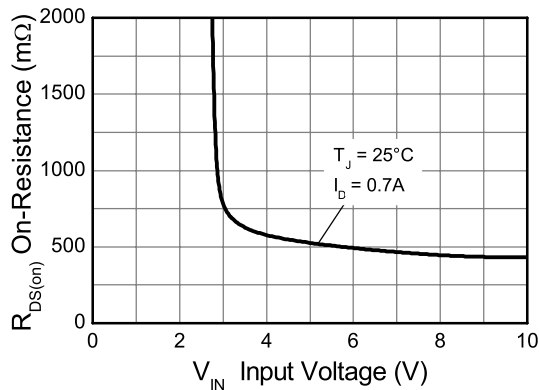

On-Resistance vs Input Voltage

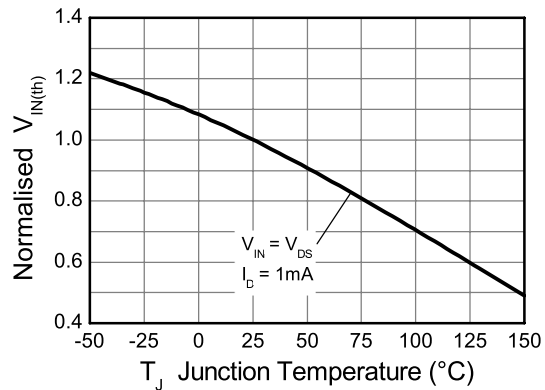

Threshold Voltage vs Temperature

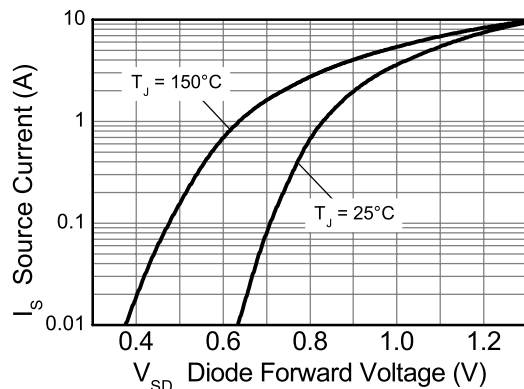

Source-Drain Diode Forward Voltage

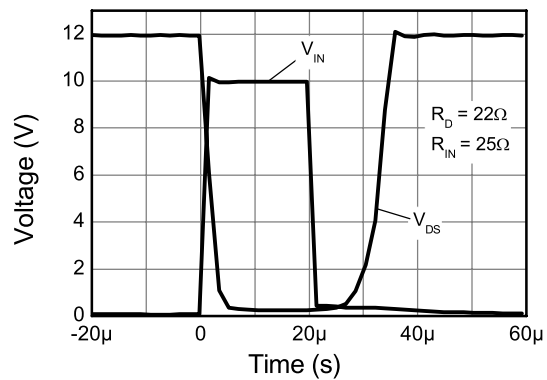

Switching Speed

Package outline - SOT223

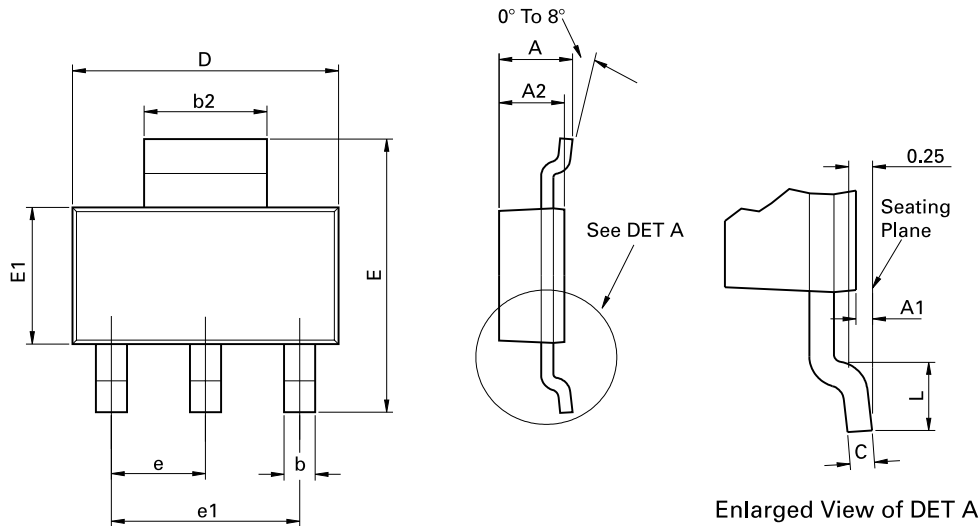

Conforms to JEDEC TO-261 AA Issue B

Dim.	Millimeters		Inches		Dim.	Millimeters		Inches	
	Min.	Max.	Min.	Max.		Min.	Max.	Min.	Max.
A	-	1.80	-	0.071	e	2.30 BSC		0.0905 BSC	
A1	0.02	0.10	0.0008	0.004	e1	4.60 BSC		0.181 BSC	
b	0.66	0.84	0.026	0.033	E	6.70	7.30	0.264	0.287
b2	2.90	3.10	0.114	0.122	E1	3.30	3.70	0.130	0.146
C	0.23	0.33	0.009	0.013	L	0.90	-	0.355	-
D	6.30	6.70	0.248	0.264	-	-	-	-	-

Note: Controlling dimensions are in millimeters. Approximate dimensions are provided in inches

Europe	Americas	Asia Pacific	Corporate Headquarters
Zetex GmbH Kustermann-park Balanstraße 59 D-81541 München Germany Telephone: (49) 89 45 49 49 0 Fax: (49) 89 45 49 49 49 europe.sales@zetex.com	Zetex Inc 700 Veterans Memorial Highway Hauppauge, NY 11788 USA Telephone: (1) 631 360 2222 Fax: (1) 631 360 8222 usa.sales@zetex.com	Zetex (Asia Ltd) 3701-04 Metroplaza Tower 1 Hing Fong Road, Kwai Fong Hong Kong Telephone: (852) 26100 611 Fax: (852) 24250 494 asia.sales@zetex.com	Zetex Semiconductors plc Zetex Technology Park, Chadderton Oldham, OL9 9LL United Kingdom Telephone: (44) 161 622 4444 Fax: (44) 161 622 4446 hq@zetex.com

For international sales offices visit www.zetex.com/offices

Zetex products are distributed worldwide. For details, see www.zetex.com/salesnetwork

This publication is issued to provide outline information only which (unless agreed by the company in writing) may not be used, applied or reproduced for any purpose or form part of any order or contact or be regarded as a representation relating to the products or services concerned. The company reserves the right to alter without notice the specification, design, price or conditions of supply of any product or service.